

VOLKSWAGEN T5GP FRONT SKIRT INSTALLATION INSTRUCTIONS

VOLKSWAGEN T5GP
ZGB 7E0 071 100

VEHICLE DESCRIPTION: K:031826
PART NUMBER:

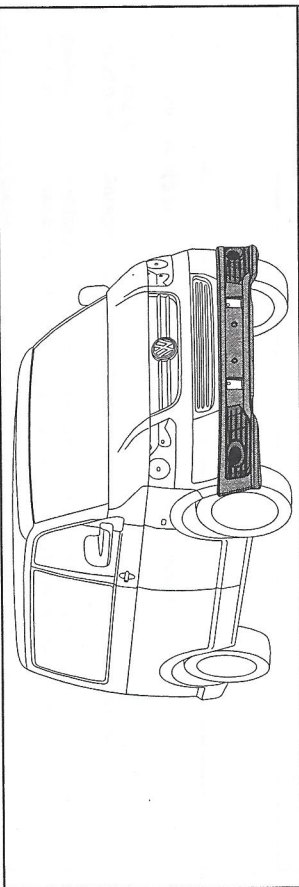

COMPONENTS LIST

NO.	COMPONENT	QTY
1.	Front Skirt	1
2.	Fog Lamp Surround LHS	1
3.	Fog Lamp Surround RHS	1
4.	Fog Lamp Cover LHS	1
5.	Fog Lamp Cover RHS	1
6.	Z Clip	2
7.	Christmas Tree Plug	6
8.	Wheel Arch Clip	4
9.	Spacer	2
10.	M5x16 Phillips Head Screw	2
11.	M5 Flat Washers	2
12.	M4X15 Mushroom Head Screw	4
13.	M4 Flat Washer	4
14.	Adhesive (not supplied) Use part number HHA381014	1

IMPORTANT:

Read instructions carefully before installation. It is strongly recommended that installation is conducted by a Volkswagen Dealer.

- Front Skirt must be painted and cured sufficiently prior to installation onto the vehicle.
- This product must be installed exactly as specified in these instructions. Failure to do so may result in improper fit and/or retention.
- Installation to be completed by 2 people.
- **WARNING:** Exercise caution when approaching steep driveways and speed bumps so as not to damage the FRONT SKIRT.

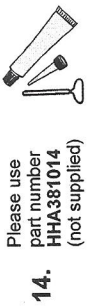

14. Please use part number HHA381014 (not supplied)

PAINTING INSTRUCTIONS

- Prior to painting, clean all surfaces to be painted using clean water and a mild detergent, do not use lacquer thinner or any solvent based products. Wipe completely dry.
- Best results will be achieved by wiping the areas to be painted with a tack rag just prior to painting.
- Select a paint (and primer if necessary) that is suitable for ABS (Acrylonitrile-Butadiene-Styrene).
- Automotive paint systems, such as Acrylics or Two Packs, can be applied directly to the Product. However, some may require a primer (check paint manufacturer specifications).
- If using a paint system which requires baking, do not expose the product to temperatures above 70° C (155° F).
- Allow a minimum of 8 hours after baking before installation on the vehicle.

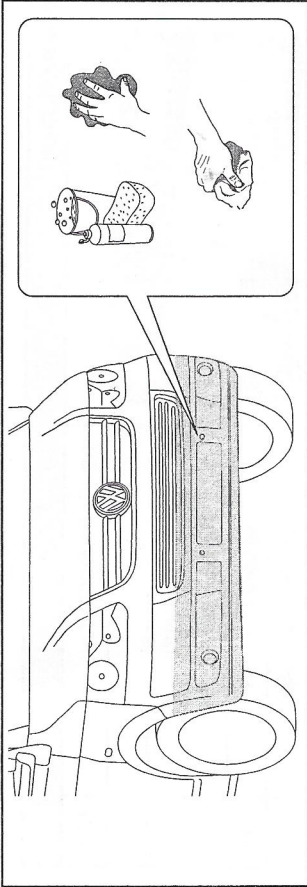

- 1.** Thoroughly clean the installation area using warm soapy water. Ensure the installation area is free of dirt, grease and wax. Dry vehicle thoroughly in all areas.

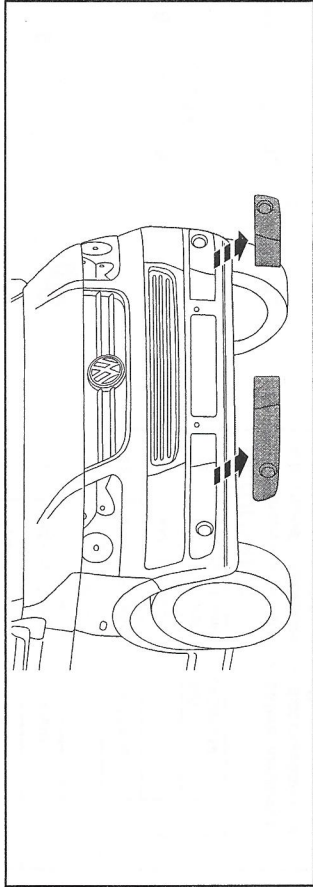

- 2.** Remove the fog lamp panels from the vehicle's bumper as shown.

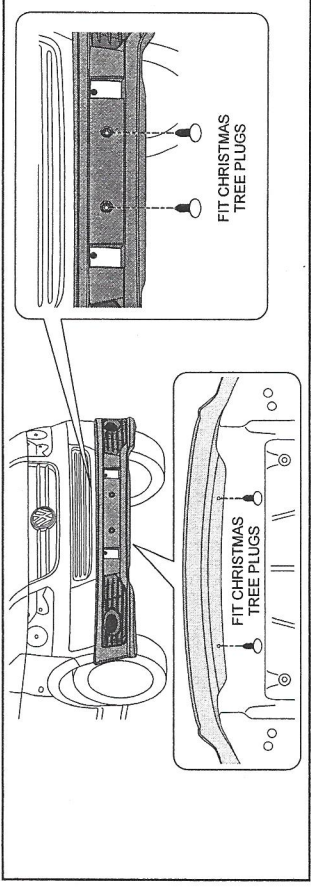

- 15.** Fit two (2) christmas tree plugs through previously drilled Ø7mm holes on the underside of the bumper as shown.
Fit two (2) christmas tree plugs through previously drilled Ø7mm holes in the front of the bumper as shown.



IMPORTANT:
DO NOT DRIVE THE VEHICLE FOR 12 HOURS TO ALLOW SUFFICIENT TIME FOR THE ADHESIVE TO CURE.

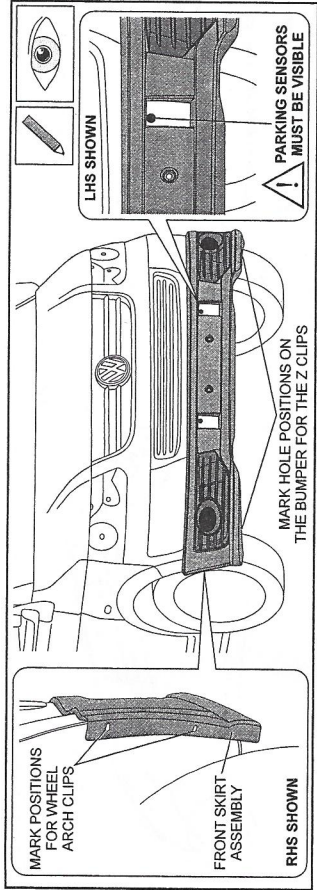

- 6.** With the front skirt assembly fitted, check to ensure the parking sensors are not covered by the skirt as shown. Ensure the front skirt is positioned correctly on the bumper, before marking the clip positions. With a non permanent marker mark the hole positions of the two (2) Z clips on the underside of the bumper. With a non permanent marker mark the positions for the four (4) wheel arch clips as shown.

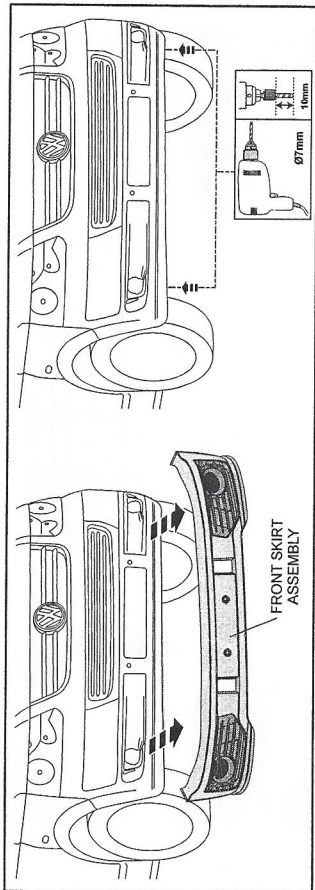

- 7.** Remove front skirt assembly from the vehicle. Drill Ø7mm holes into the bumper at previously marked positions for the Z clips. Remove all burrs and sharp edges.

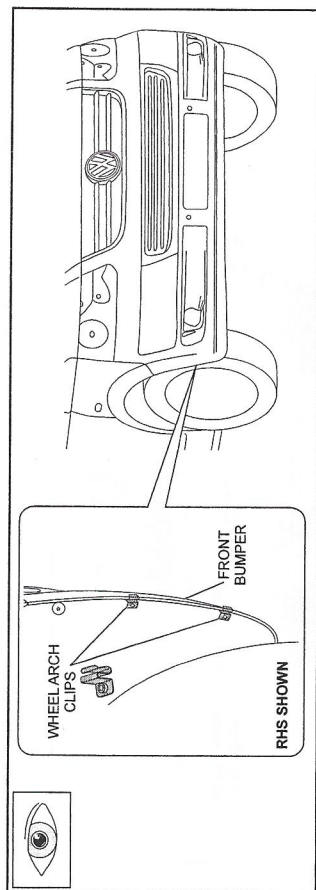

- 8.** Install the wheel arch clips to the vehicle as shown, aligning them to the previously marked lines.

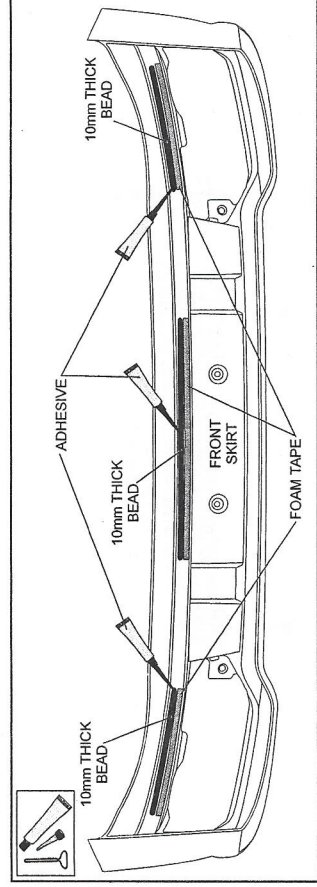

- 9.** Apply a 10mm bead of adhesive to the area above each of the three (3) foam strips.

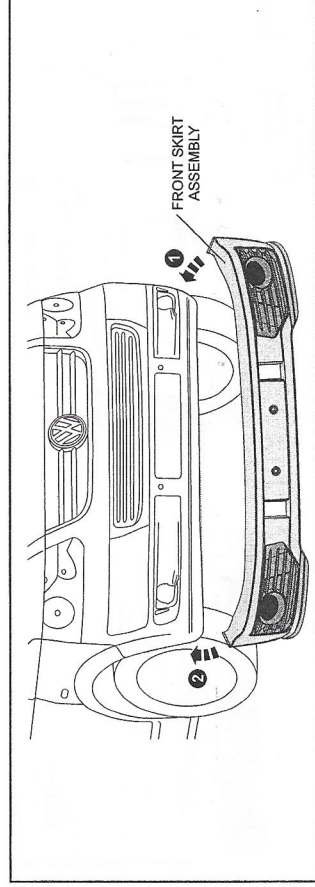

- 10.** Carefully trial fit the front skirt assembly onto the vehicle's bumper, fitting one end first then position the other.

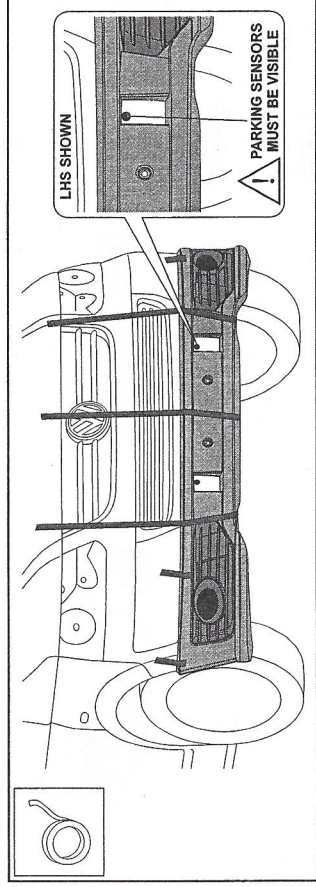

- 11.** Apply masking tape to the front skirt to hold it in position while adhesive is curing and remaining hardware is fitted.

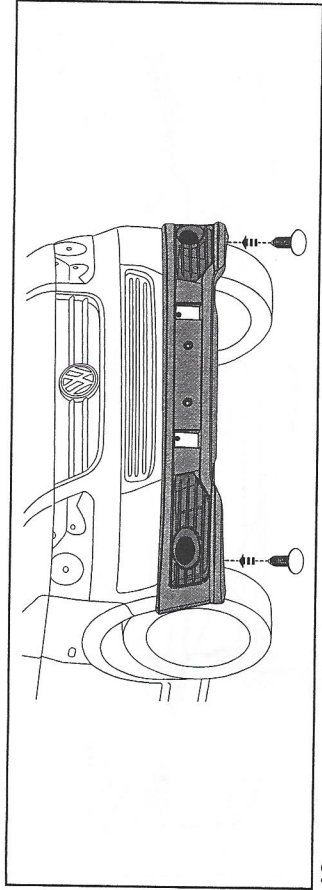

12. Fit two (2) christmas tree plugs through previously drilled $\varnothing 7\text{mm}$ hole to secure the Z clips to the bumper.

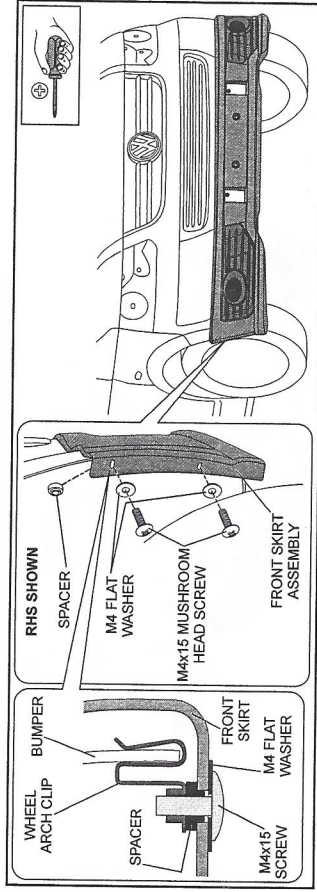

13. Attach the front skirt to the wheel arches by securing one (1) M4x15 mushroom head screw and M4 flat washer to the bottom wheel arch clip as shown.
Fit a spacer at the top between the front skirt and previously installed wheel arch clip then secure with one (1) M4x15 mushroom head screw and M4 flat washer as shown.
Repeat process for the other side of the vehicle.

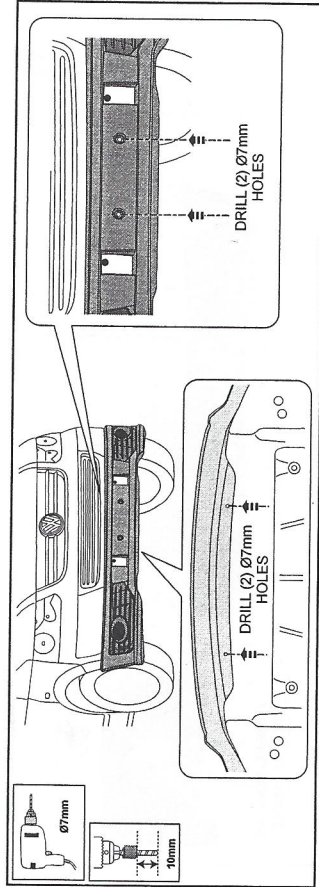

14. Underneath the front bumper Drill two (2) $\varnothing 7\text{mm}$ holes into the bumper using the 2 holes in the front skirt as a guide. Drill two (2) $\varnothing 7\text{mm}$ holes into the front of the bumper using the 2 holes in the front skirt as a guide, as shown.

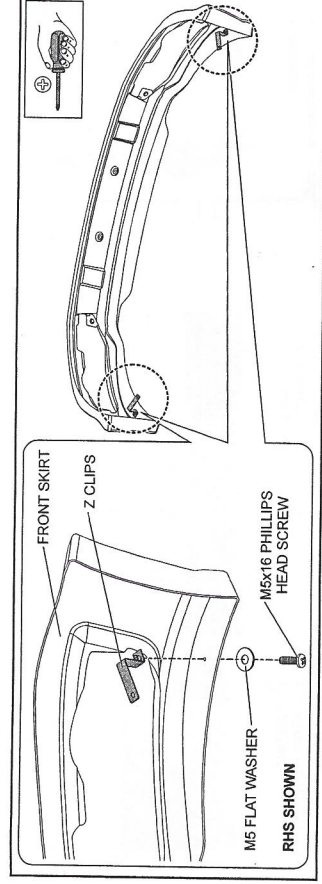

3. Attach the Z clips to the inside of the front skirt and secure with M5x16 phillips head screw and M5 flat washer as shown.

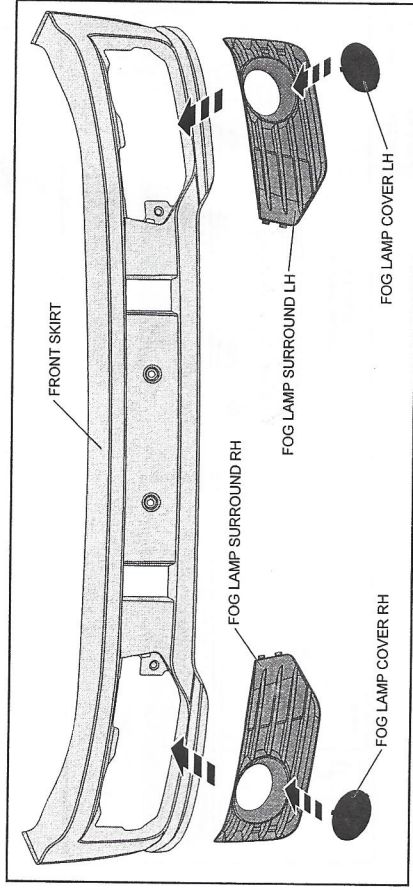

4. Fit fog lamp cover LH to fog lamp surround LH as shown.
Fit fog lamp cover RH to fog lamp surround RH as shown.
IMPORTANT: Ensure the fog lamp covers are fitted with the single (1) clip pointing up and the two (2) clips pointing down as shown.
Fit fog lamp surrounds with covers to the front skirt as shown

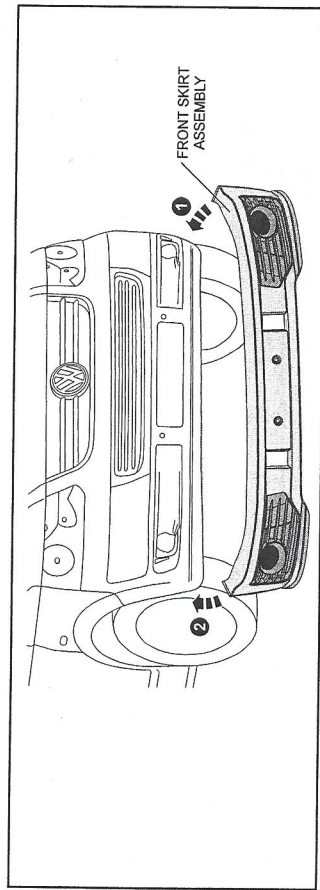

5. Carefully trial fit the front skirt assembly onto the vehicle's bumper, fitting one end first then position the other.